

G-8056H-LM45E0-T

PHASE Series

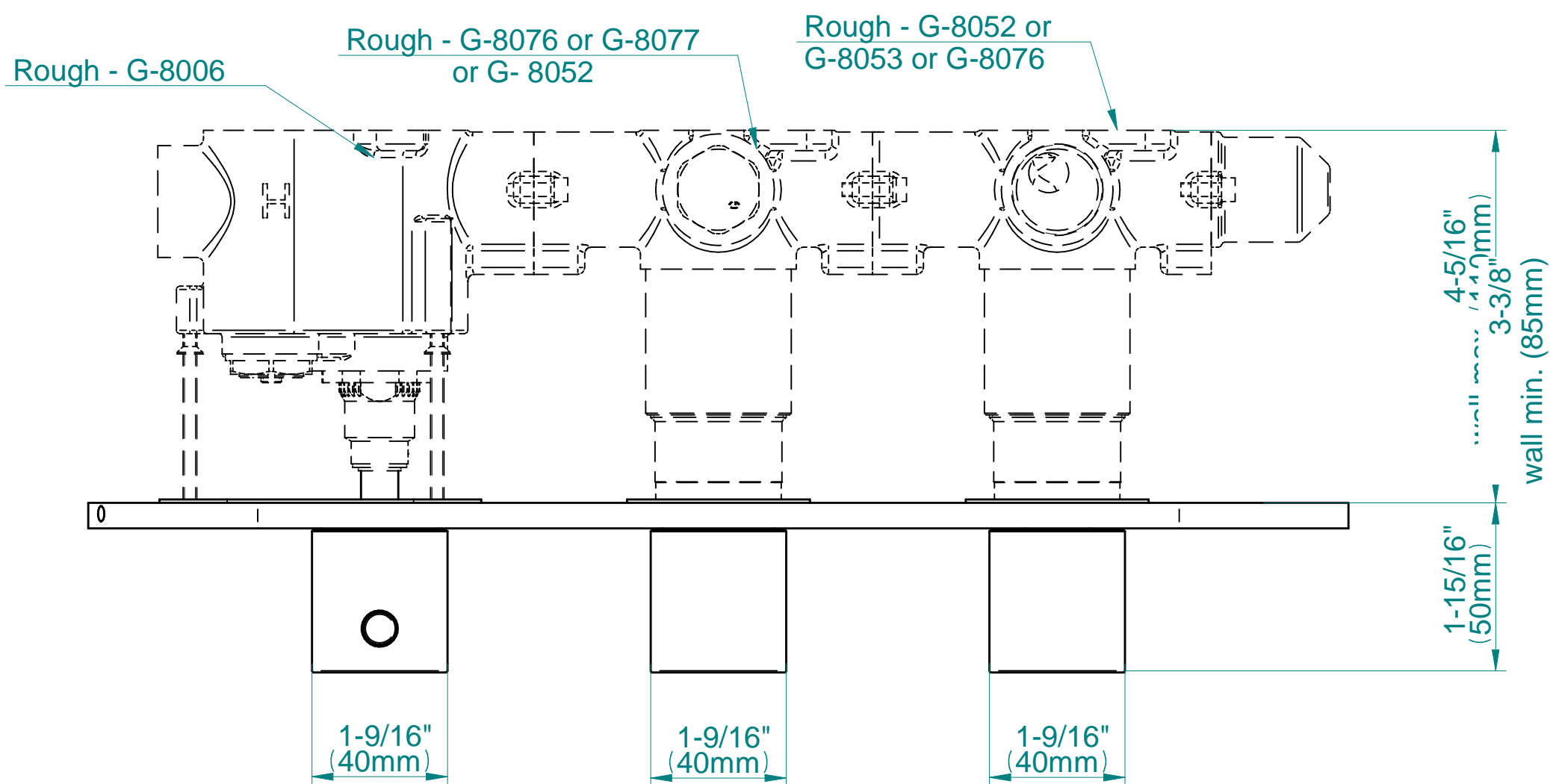
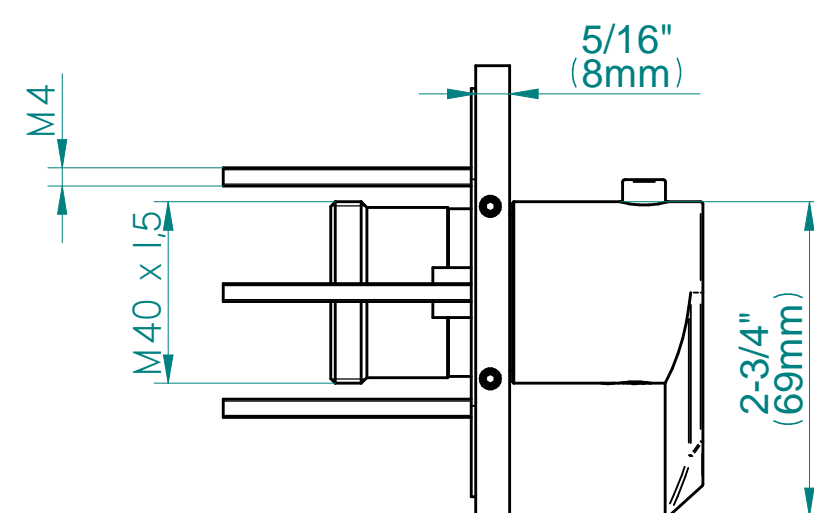
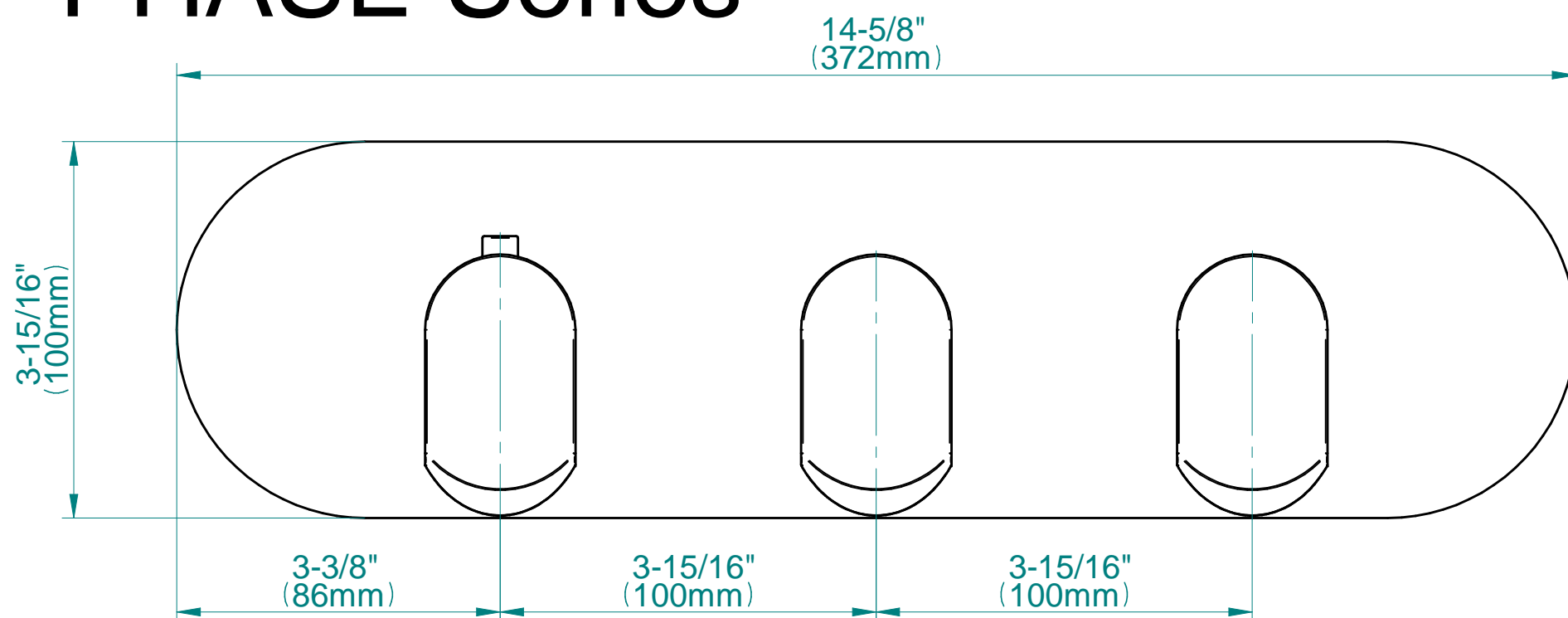

GRAFF[®]
CUTTING EDGE DESIGN